

JVC

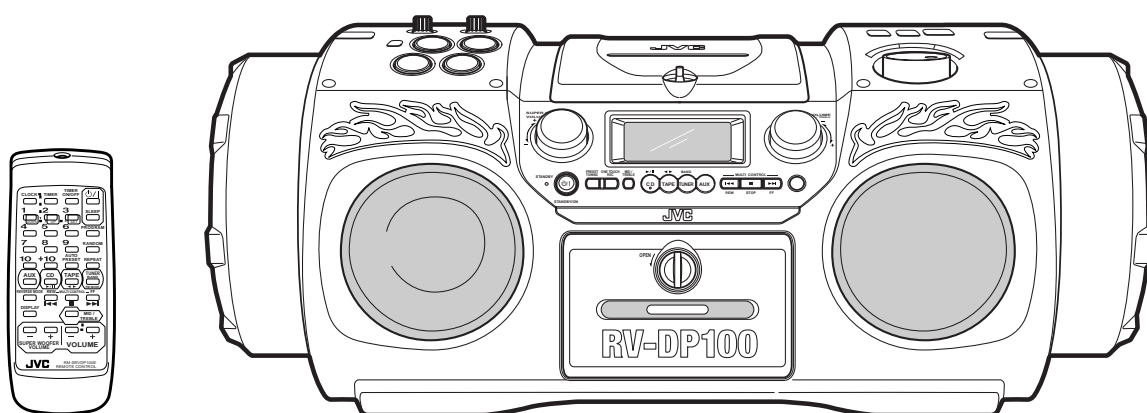

POWERED WOOFER CD SYSTEM

RV-DP100BK



COMPACT
disc
DIGITAL AUDIO

INSTRUCTIONS

For Customer Use:

Enter below the Model No. and Serial No. which are located either on the rear, bottom or side of the cabinet. Retain this information for future reference.

Model No. _____

Serial No. _____

LVT0439-002A

[B]

Warnings, Cautions and Others

IMPORTANT for the U.K.

DO NOT cut off the mains plug from this equipment. If the plug fitted is not suitable for the power points in your home or the cable is too short to reach a power point, then obtain an appropriate safety approved extension lead or consult your dealer.

BE SURE to replace the fuse only with an identical approved type, as originally fitted.

If nonetheless the mains plug is cut off ensure to remove the fuse and dispose of the plug immediately, to avoid a possible shock hazard by inadvertent connection to the mains supply.

If this product is not supplied fitted with a mains plug then follow the instructions given below:

IMPORTANT:

DO NOT make any connection to the terminal which is marked with the letter E or by the safety earth symbol or coloured green or green-and-yellow.

The wires in the mains lead on this product are coloured in accordance with the following code:

Blue : Neutral
Brown : Live

As these colours may not correspond with the coloured markings identifying the terminals in your plug proceed as follows:

The wire which is coloured blue must be connected to the terminal which is marked with the letter N or coloured black.

The wire which is coloured brown must be connected to the terminal which is marked with the letter L or coloured red.

IF IN DOUBT - CONSULT A COMPETENT ELECTRICIAN.

Caution — O/I switch!

Disconnect the mains plug to shut the power off completely. The O/I switch in any position does not disconnect the mains line. The power can be remote controlled.

Caution: Proper Ventilation

To avoid risk of electric shock and fire, and to prevent damage, locate the apparatus as follows:

- 1 Front: No obstructions and open spacing.
- 2 Sides/ Top/ Back: No obstructions should be placed in the areas shown by the dimensions below.
- 3 Bottom: Place on the level surface. Maintain an adequate air path for ventilation by placing on a stand with a height of 10 cm or more.

Front view

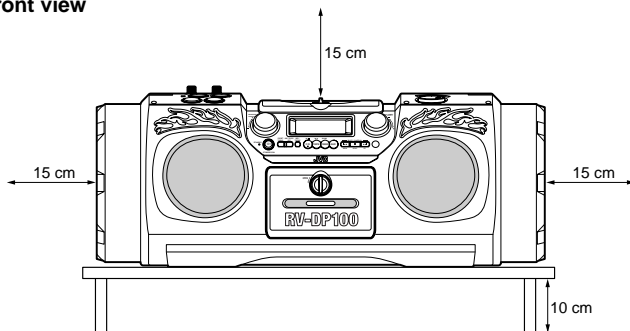

Side view

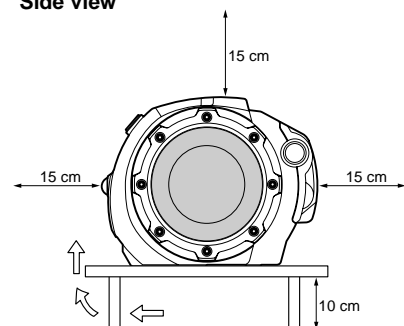

IMPORTANT FOR LASER PRODUCTS

REPRODUCTION OF LABELS

- 1 CLASSIFICATION LABEL, PLACED ON EXTERIOR SURFACE

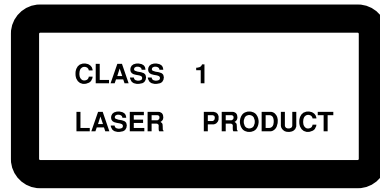

- 2 WARNING LABEL, PLACED INSIDE THE UNIT

DANGER: Invisible laser radiation when open and interlock failed or defeated. AVOID DIRECT EXPOSURE TO BEAM. (e)

WARNING: Osynlig laserstrålning när denna del är öppnad och spärren är urkopplad. Betrakta ej strålen. (s)

ADVARSEL: Usynlig laserstrålning ved åbning, når sikkerhedsafbrydere er ude af funktion. Undgå udsættelse for stråling (d)

VARO: Avattaessa ja suo-
-äukitus ohitettaessa olet
aktiina näkymättömälle
lasersäteilylle. Älä katso
säteeseen. (f)

- 1 CLASS 1 LASER PRODUCT
- 2 **DANGER:** Invisible laser radiation when open and interlock failed or defeated. Avoid direct exposure to beam.
- 3 **CAUTION:** Do not open the top cover. There are no user serviceable parts inside the Unit; leave all servicing to qualified service personnel.

CAUTION

To reduce the risk of electrical shocks, fire, etc.:

- 1 Do not remove screws, covers or cabinet.
- 2 Do not expose this appliance to rain or moisture.

SAFETY INSTRUCTIONS

“SOME DOS AND DON'TS ON THE SAFE USE OF EQUIPMENT”

This equipment has been designed and manufactured to meet international safety standards but, like any electrical equipment, care must be taken if you are to obtain the best results and safety is to be assured.

★★

Do read the operating instructions before you attempt to use the equipment.

Do ensure that all electrical connections (including the mains plug, extension leads and interconnections between pieces of equipment) are properly made and in accordance with the manufacturer's instructions. Switch off and withdraw the mains plug when making or changing connections.

Do consult your dealer if you are ever in doubt about the installation, operation or safety of your equipment.

Do be careful with glass panels or doors on equipment.

★★

DON'T continue to operate the equipment if you are in any doubt about it working normally, or if it is damaged in any way—switch off, withdraw the mains plug and consult your dealer.

DON'T remove any fixed cover as this may expose dangerous voltages.

DON'T leave equipment switched on when it is unattended unless it is specifically stated that it is designed for unattended operation or has a standby mode.
Switch off using the switch on the equipment and make sure that your family know how to do this.

Special arrangements may need to be made for infirm or handicapped people.

DON'T use equipment such as personal stereos or radios so that you are distracted from the requirements of traffic safety. It is illegal to watch television whilst driving.

DON'T listen to headphones at high volume as such use can permanently damage your hearing.

DON'T obstruct the ventilation of the equipment, for example with curtains or soft furnishings.

Overheating will cause damage and shorten the life of the equipment.

DON'T use makeshift stands and NEVER fix legs with wood screws — to ensure complete safety always fit the manufacturer's approved stand or legs with the fixings provided according to the instructions.

DON'T allow electrical equipment to be exposed to rain or moisture.

ABOVE ALL

- NEVER let anyone, especially children, push anything into holes, slots or any other opening in the case -this could result in a fatal electrical shock.;
- NEVER guess or take chances with electrical equipment of any kind
- it is better to be safe than sorry!

Thank you for purchasing the JVC Powered Woofer CD System.
 We hope it will be a valued addition to your home as well as your outdoor life, giving you years of enjoyment.
 Be sure to read this instruction manual carefully before operating your new stereo system.
 In it you will find all the information you need to set up and use the system.
 If you have a query that is not answered by the manual, please contact your dealer.

Features

Here are some of the things that make your System both powerful and simple to use.

- The controls and operations have been redesigned to make them very easy to use, freeing you to just enjoy the music.
 - With JVC's **COMPU PLAY** you can turn on the System and automatically start the Radio, CD Player, or Cassette Deck with a single touch. (Only when AC power is used.)
- The System is equipped with 16-cm dia. super woofers that provide powerful bass.
- A 45-station preset capability (30 FM and 15 AM (MW/LW)) in addition to auto-seek and manual tuning.
- CD options include repeat, random and program play.
- Auto-reverse tape function
- Rhythm Machine provides various rhythm patterns, scratch sounds, and drum pad patterns.
- Timer functions; set the system to automatically come on, switch off.



How This Manual Is Organized

- Basic information that is the same for many different functions - e.g. setting the volume - is given in the section 'Basic Operations', and not repeated under each function.
- The names of buttons/controls and display messages are written in all capital letters: e.g. TUNER BAND, "NO DISC".
- System functions are written with an initial capital letter only: e.g. Normal Play.

Use the table of contents to look up specific information you require.

We've enjoyed making this manual for you, and hope it serves you in enjoying the many features built into your System.

IMPORTANT CAUTIONS

1. Where to place the System

- Select a place which is level, dry and neither too hot nor too cold. (Between 0°C and 40°C.)
- Leave sufficient distance between the System and a TV.
- Do not use the System in a place subject to vibrations.

2. Power cord

- Do not handle the power cord with wet hands!
- Some power is always consumed as long as the power cord is connected to the wall outlet.
- When unplugging the System from the wall outlet, always pull the plug, not the power cord.

3. When carrying the System

- Remove a CD from the System.
- Disconnect all the cords from the System.

4. Malfunctions, etc.

- There are no user serviceable parts inside. In case of system failure, unplug the power cord and consult your dealer.
- Do not insert any metallic object into the System.

Table of Contents

Features.....	1	Using the Cassette Deck (Recording).....	13
How This Manual Is Organized.....	1	Using the Rhythm Machine.....	15
IMPORTANT CAUTIONS.....	1	Listening to an Auxiliary Equipment.....	20
Getting Started.....	2	Using the Microphone/Guitar.....	21
Basic Operations.....	6	Using the Timers.....	22
Using the Tuner.....	8	Care And Maintenance.....	24
Using the CD Player.....	10	Troubleshooting.....	Back cover
Using the Cassette Deck (Listening to a Tape)....	12	Specifications.....	Back cover

Getting Started

Accessories

Check that you have all of the following items, which are supplied with the System.

- Power Cord (1)
- Remote Control (1)
- Batteries (2)
- Shoulder Strap (1)

If any of these items are missing, contact your dealer immediately.

How To Carry the System

To carry the System, attach the supplied shoulder strap to each end of the System.

Press in the metal fitting of the shoulder strap and hook it over the shaft at each end of the System as shown in the figure.

To detach the shoulder strap, press in the metal fitting and unhook it from the shaft.

The shoulder strap is adjustable in length and has the remote control case.

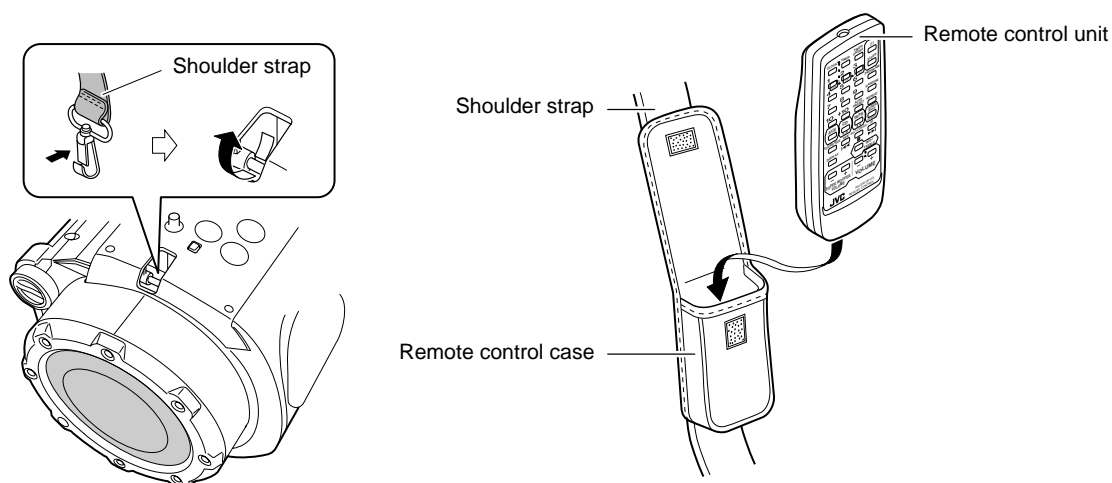

How To Put Batteries In the Remote Control

Match the polarity (+ and -) on the batteries with the + and - markings in the battery compartment.

R6P(SUM-3)/AA(15F)

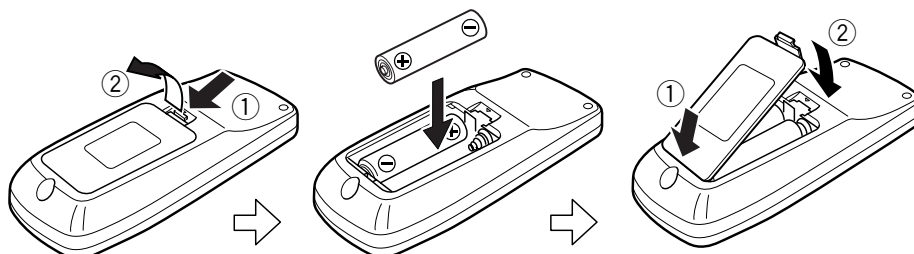

CAUTION: Handle batteries properly.

To avoid battery leakage or explosion:

- Remove batteries when the Remote Control will not be used for a long time.
- When you need to replace the batteries, replace both batteries at the same time with new ones.
- Don't use an old battery with a new one.
- Don't use different types of batteries together.

Using the Remote Control

The Remote Control makes it easy to use many of the functions of the System from a distance of up to 7m (23 feet) away. You need to point the Remote Control at the remote sensor on the System's front panel.

Note: If you point the Remote Control from the slant direction, the above distance will be shortened.

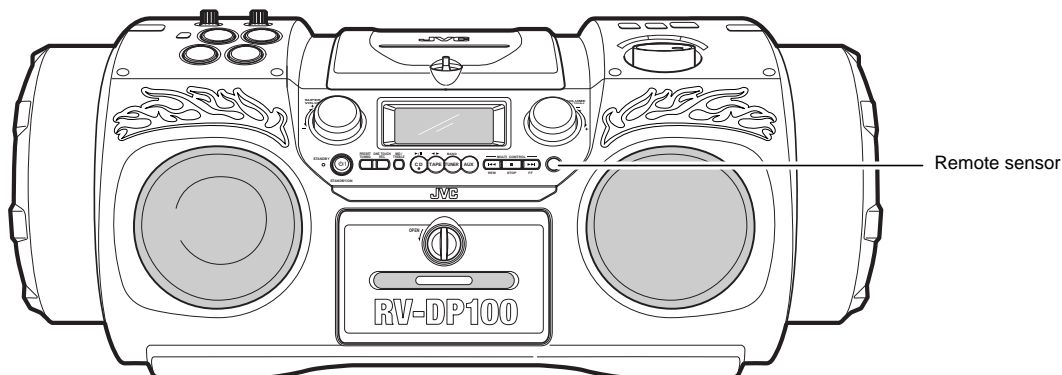

CAUTION: Make all connections before plugging the System into an AC power outlet.

Connecting Auxiliary Equipment

Connect a signal cord (not supplied) between the AUX IN terminal on the System and the output terminals of your auxiliary equipment (e.g. turntable or MD player). You can listen to this source.

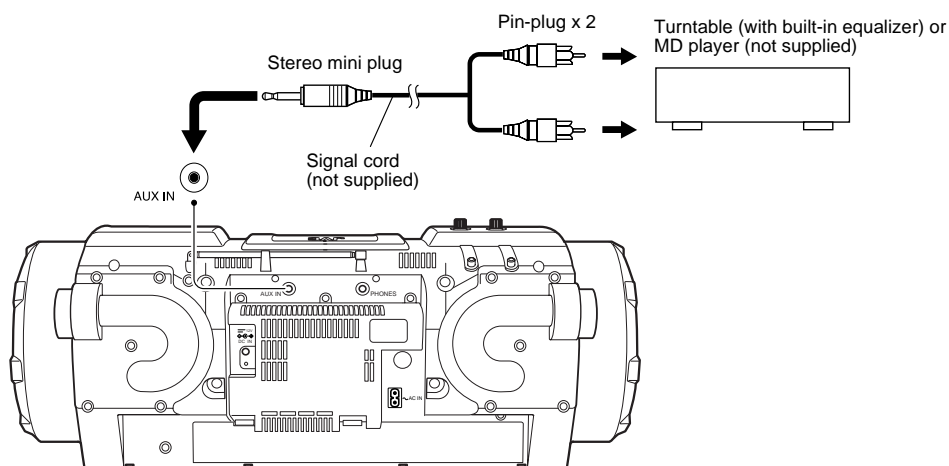

Connecting the AC Power Cord

Firmly insert the supplied AC power cord into the AC inlet on the back of the System.

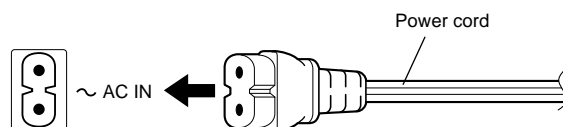

CAUTIONS:

- **ONLY USE THE JVC POWER CORD PROVIDED WITH THIS SYSTEM TO AVOID MALFUNCTION OR DAMAGE TO THE SYSTEM.**
- **BE SURE TO UNPLUG THE POWER CORD FROM THE OUTLET WHEN GOING OUT OR WHEN THE SYSTEM IS NOT IN USE FOR AN EXTENDED PERIOD OF TIME.**

Now you can plug the AC power cord into the wall outlet, and your System is at your command!!

Memory Backup Batteries

It is recommended that memory backup batteries are loaded in the System to prevent the contents of the memory from being erased when a power failure occurs.

1. Open the battery cover on the back of the System by pulling it toward you while pressing the tabs as shown by the arrows.

2. Load three batteries (not supplied) in the battery compartment in the order of "1" to "3".

- Be careful to put the batteries with the "+" and "-" terminals positioned correctly.

3. Securely close the battery cover.

To remove the batteries, remove the battery "3" first.

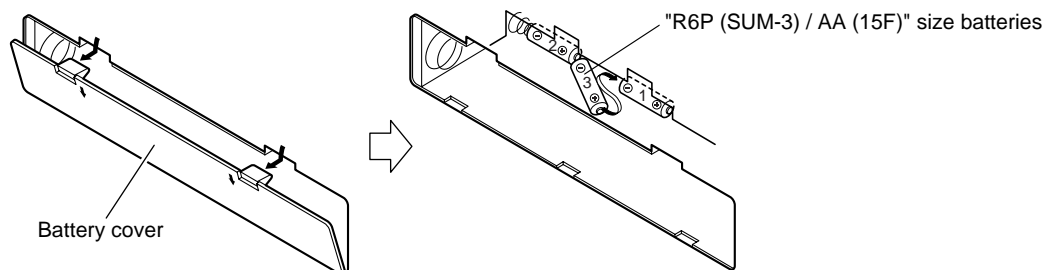

Notes:

- The memory backup batteries will not be consumed as long as the power is supplied from an AC outlet, loaded 10 batteries, or car battery (DC12V). However, if no power is supplied to the System, the memory backup batteries should be replaced with new ones approximately every 12 months to securely maintain the contents of the memory.
- Before replacing the memory backup batteries, always connect the AC power cord to the System to prevent the contents of memory from being erased.
- When a power failure occurs, the time indication disappears from the display to save the battery power of the memory backup batteries.

CAUTION: Handle batteries properly.

To avoid battery leakage or explosion:

- When you need to replace the batteries, replace all batteries at the same time with new ones. Before replacing, you need to supply AC power to the System.
- Don't use an old battery with new ones.
- Don't use different types of batteries together.

How To Operate the System on Batteries

You can operate the System on 10 batteries.

1. Open the battery cover on the back of the System by pulling it toward you while pressing the tabs as shown by the arrows.

2. Put 10 batteries (not supplied) in the battery compartment in the order of "1" to "10" as shown.

- Be careful to put the batteries with the "+" and "-" terminals positioned correctly.

3. Securely close the battery cover.

To remove the batteries, remove the battery "10" first.

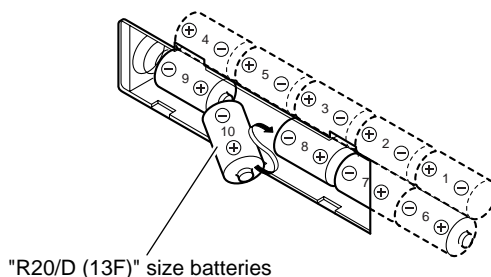

Notes:

- When you operate the System on mains (AC) power or on car battery (DC12V), the power source automatically switches from batteries to AC or DC12V. However, you should remove the 10 batteries when operating on AC power or car battery (DC12V).
- When the batteries are exhausted, mistracking will occur during CD playback or sound will be distorted intermittently during tape playback. You need to replace the batteries at a time.
- It is recommended that the AC power cord be used when recording important material or listening to a CD.

CAUTION: Handle batteries properly.

To avoid battery leakage or explosion:

- Remove 10 batteries when the System will not be used for a long time.
- When you need to replace the batteries, replace all batteries at the same time with new ones.
- Don't use an old battery with new ones.
- Don't use different types of batteries together.

How To Operate the System on Car Battery (DC12V)

You can operate the Unit on car battery (DC12V).

- 1 First, connect the car adapter to the DC IN 12V jack on the back of the System, to avoid a short-circuit of the car adapter.**
- 2. Next, connect the car adapter to the cigarette lighter socket (DC12V) of the car.**

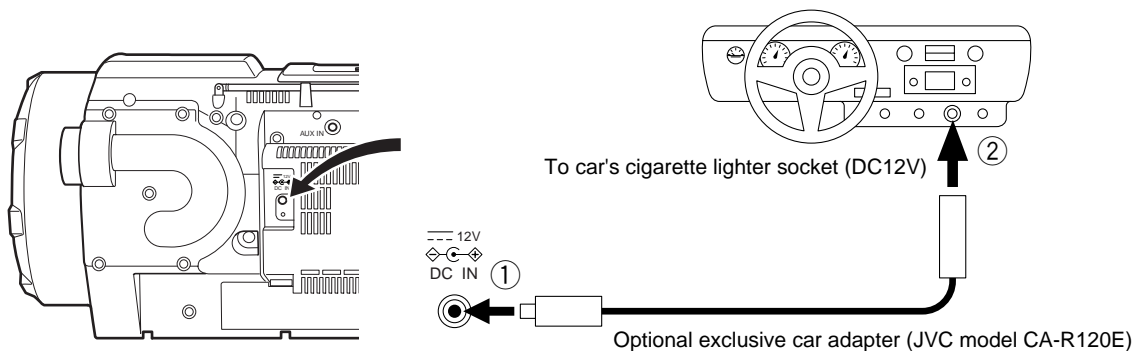

CAUTION: Use the System in a car properly.

- Be sure to use the specified car adapter (JVC model CA-R120E) to prevent mishaps or damage resulting from different polarity design.
- Unplug the AC power cord from the System when using the System with a car adapter.
- For safety, stop the car before performing operations.
- Be sure to start the engine when you use the car adapter, otherwise the car battery will be exhausted.
- During transport, stabilize the System in a box, etc.
- The Unit is not waterproof or dustproof. To prevent malfunctions, do not leave the System in a car for a long time.

COMPU PLAY

JVC's COMPU PLAY feature lets you control the most frequently used System functions with a single touch.

With One Touch Operation you can play a CD, a tape, or turn on the radio with a single press of the play button for that function. One Touch Operation turns the power on for you, then starts the function you have specified. If the System is not ready (no CD in place, for example), the System still powers on so you can insert a CD.

How One Touch Operation works in each case is explained in the section dealing with that function.

The COMPU PLAY buttons are:

On the Unit

- CD ►/|| button
- TAPE ◀▶
- TUNER BAND button
- AUX button

On the Remote Control

- CD ►/|| button
- TAPE ◀▶
- TUNER BAND button
- AUX button

Note: The COMPU PLAY feature is ineffective when the System is operated on batteries or car battery (DC12V).

Basic Operations

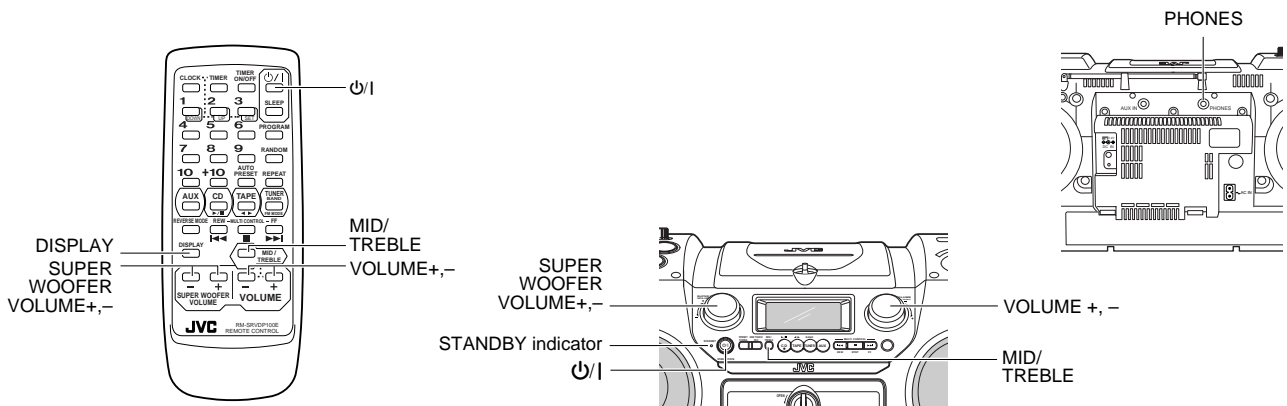

Turning the Power On and Off

Note: The lighting condition for the "STANDBY" indicator and the display differs depending on the power source being used, as follows:

Power source	"STANDBY" indicator/Display
AC power	<ul style="list-style-type: none"> The "STANDBY" indicator lights when power is turned off. Backlighting of the display is illuminated when power is turned on.
Batteries or car battery (DC12V)	<ul style="list-style-type: none"> The "STANDBY" indicator does not light. Backlighting of the display is not illuminated.

Turning the System On

Press the P/I button.

- When the System is operated on batteries or car battery (DC12V), press the P/I button on the Unit. The "STANDBY" indicator goes out when the System is operated on AC power. The display comes on and the System is ready to continue in the mode it was in when the power was last turned off.

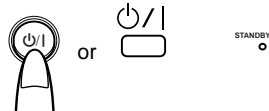

- For example, if the last thing you were doing was listening to a CD, you are now ready to listen to a CD again. If you wish, you can change to another source.
- If you were listening to the Tuner last, the Tuner comes on playing the station it was last set to.

Turning the System Off

Press the P/I button.

The "STANDBY" indicator lights up when the System is operated on AC power. The contents of the display changes to the clock, and "CLOCK" indicator and the time are displayed without backlighting.

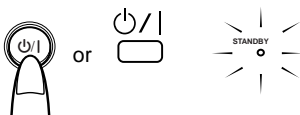

- Some power is always consumed even though power is turned off (called Standby Mode).
- To switch off the System completely, unplug the AC power cord from the AC outlet. When you unplug the AC power cord, the clock will be reset to "0:00" when no memory backup batteries are installed.

Adjusting the Volume

You can adjust the volume level between 0 and 50.

Using the Unit

Turn the VOLUME control clockwise to increase the volume or turn it counterclockwise to decrease the volume.



Using the Remote Control

Press the VOLUME + button to increase the volume or press the VOLUME - button to decrease it.

When you keep pressed the VOLUME + or - button, the volume changes rapidly.

CAUTION: DO NOT start playing any source without first setting the volume to minimum, as a sudden blast of sound can damage your hearing, speakers and/or headphones.

For private listening

Connect a pair of headphones to the PHONES jack. No sound comes out of the speakers.

Be sure to turn down the volume before connecting or putting on headphones.

Adjusting the Super Woofer Volume

You can adjust the bass level between BASS 1 (minimum) and BASS 6 (maximum). You can use this effect only for playback.

Using the Unit

Turn the SUPER WOOFER VOLUME control clockwise to increase the bass level or turn it counterclockwise to decrease the bass level.

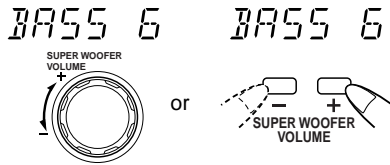

Using the Remote Control

Press the SUPER WOOFER VOLUME + button to increase the bass level or press the SUPER WOOFER VOLUME - button to decrease it.

Note: This function is not effective when the headphones are in use.

Tone Control (MID/TREBLE)

You can control the tone by changing the mid and the treble between -6 and +6. (0: Flat)

Using the Unit

1. Press the MID/TREBLE button to select MID or TREBLE.

Each time you press the button, the display changes as follows: MID→TREBLE→Current sound source→(back to the beginning)

2. Turn the VOLUME control clockwise or counterclockwise within five seconds to adjust the mid/treble level.

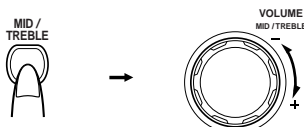

(Within 5 seconds)

MID-6 MID+6
TRE-6 TRE+6

Using the Remote Control

1. Press the MID/TREBLE button to select MID or TREBLE.

Each time you press the button, the display changes as follows: MID→TREBLE→Current sound source→(back to the beginning)

2. Press the VOLUME + or VOLUME - button within five seconds to adjust the mid or treble level.

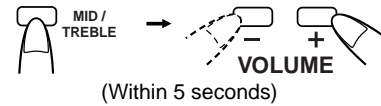

(Within 5 seconds)

MID-6 MID+6
TRE-6 TRE+6

Showing the Time (DISPLAY)

In Standby mode, the backlight of the display goes out, and the "CLOCK" indicator and the current time (clock) appear on the display.

While the power is turned on, you can see the current time (clock) at any time, as follows:

Press the DISPLAY button on the Remote Control. Each time you press the button, the display changes as follows:

Current sound source (e.g. FM103.50 MHz)→Clock→(back to the beginning)

Note: To let work the clock, you need to set the clock first. (See "Setting the Clock" on page 22.)

Using the Tuner

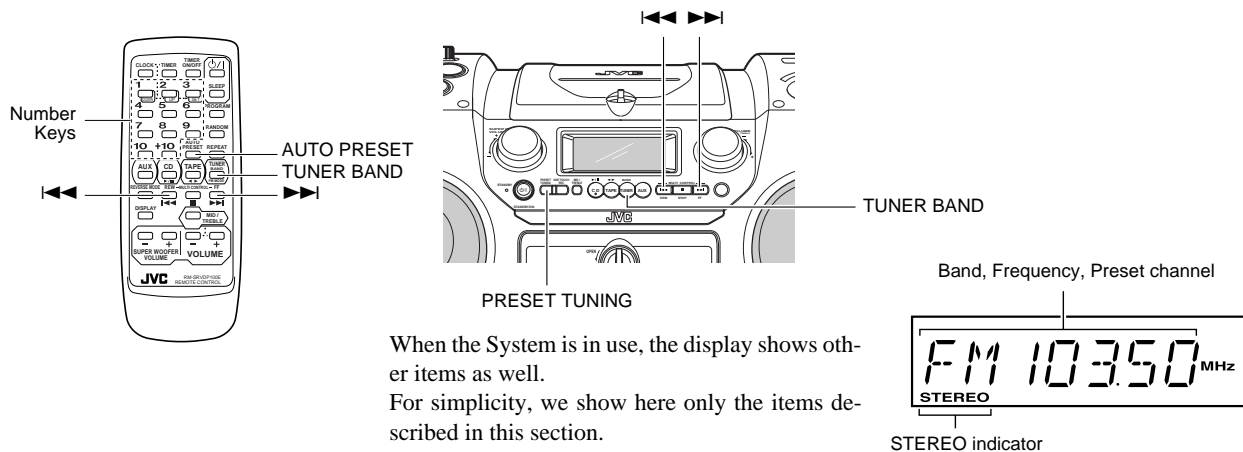

When the System is in use, the display shows other items as well.
For simplicity, we show here only the items described in this section.

You can listen to FM and AM (MW/LW) stations. Stations can be tuned in manually, automatically, or from preset memory storage.

■ Before listening to the radio:

- Fully extend the FM telescopic antenna.

One Touch Radio

- This operation is effective only when the System is operated on AC power.

Just press the TUNER BAND button to turn on the System and start playing the station you were last tuned to.

- You can switch from any other sound source to the radio by pressing the TUNER BAND button.

Tuning In a Station

1. Press the TUNER BAND button.

The Band and Frequency you were last tuned to appear on the display.

Each time you press the button, the band and FM mode change as follows:

FM→**FM-MONO**→**AM**→(back to the beginning)

- In FM mode, when you tune in an FM broadcast and the "STEREO" indicator lights up, you can hear stereo effects. If an FM stereo broadcast is hard to receive or noisy, select FM-MONO mode. The "STEREO" indicator will go out. Reception improves, but you lose any stereo effect.

2. Select a station using one of the following methods.

■ Manual Tuning

Press the ◀◀ or ▶▶ button repeatedly to move from frequency to frequency until you find the station you want.

OR

■ Auto Tuning

If you press and hold the ◀◀ or ▶▶ button for one second or more, the frequency changes down, or up, automatically until a station is found.

OR

■ Preset Tuning (Possible only after presetting stations)

Select the desired preset number (displayed as "P-XX" on the display) using the PRESET TUNING button on the Unit or the number keys on the Remote control. After 1 second, the display will show the preset number's band and frequency.

P-12 → FM 103.50

(After 1 second)

PRESET TUNING button: Each time you press the button, the preset number increases.

Number keys:

- To select P-5, press 5.
- To select P-15, press +10 then 5.
- To select P-20, press +10 once then press 10.

3. Turn the FM antenna for the best reception.

For an AM (MW/LW) broadcast, turn the Unit to obtain the best reception. Placing the Unit near the window, for example, will improve AM reception.

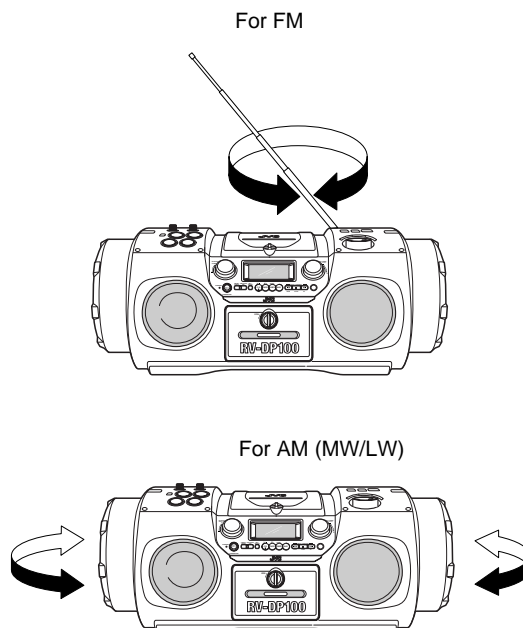

Presetting Stations

You can preset up to 30 FM stations and up to 15 AM (MW/LW) stations.

Note: Preset numbers may have been set to factory test frequencies prior to shipment. This is not a malfunction. You can preset the stations you want into memory by following one of the presetting methods below:

Manual Presetting

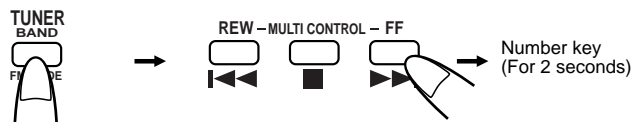

- 1. Select a band (either AM or FM/FM-MODE) by pressing the TUNER BAND button.**
- 2. Press the << or >> button to tune in a station.**
- 3. Press the number key for more than two seconds to store in memory for the desired preset number.**

The preset number blinks for four seconds and then the preset station for the preset number appears.

Example: To preset the tuned station to the preset number 15, press +10 then 5 for more than two seconds. The display changes as follows.

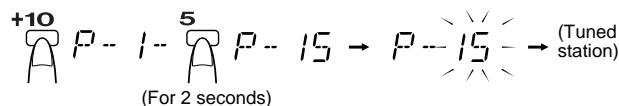

- 4. Repeat above steps 1 to 3 for each station you want to store in memory with a preset number.**

To change the preset stations, repeat the same steps as above to overwrite a new station.

Auto Presetting

In each band, you can automatically preset FM-30, AM(MW/LW)-15 stations. Preset numbers will be allocated as stations are found, starting from the lowest station and moving up the frequency.

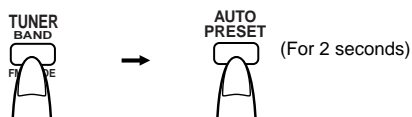

- 1. Select a band (either AM or FM/FM-MODE) by pressing the TUNER BAND button.**
- 2. Press one of the following buttons.**

On the Unit:

Press the PRESET TUNING button for more than two seconds.

On the Remote Control:

Press the AUTO PRESET button on the Remote Control for more than two seconds.

- 3. Repeat steps 1 and 2 for the other band.**

■ If you want to change the preset stations, carry out the Manual Presetting for the desired preset numbers.

CAUTION: To prevent the preset stations from being erased because of a power failure, etc., install memory backup batteries in the System. (See page 4.)

Using the CD Player

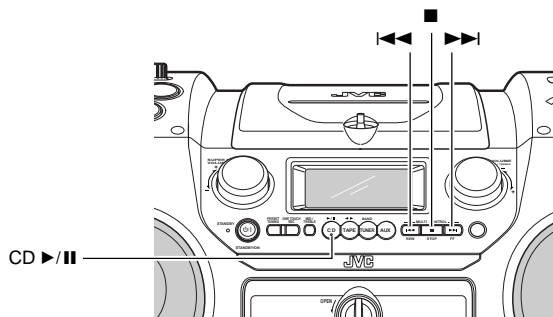
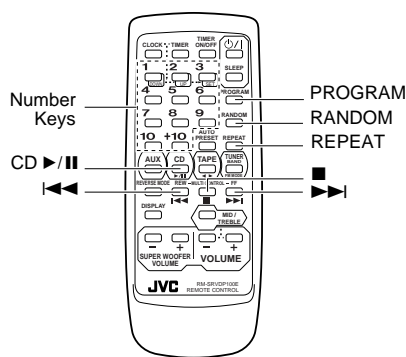

When the System is in use, the display shows other items as well. For simplicity, we show here only the items described in this section.

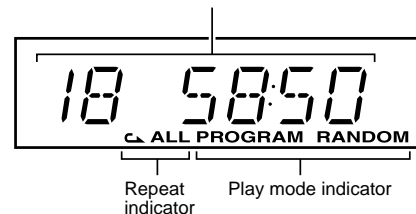

You can use Normal, Random, Program or Repeat Play. Repeat Play can repeat all the tracks or just one of the tracks on the CD. Here are the basic things you need to know to play a CD and locate the different tracks on it.

The Quickest Way To Start a CD Is With the One Touch Operation (effective only when the System is operated on AC power)

- Press the CD▶/|| button.
- The power is automatically turned on. If a CD is already inserted, it will start playing from the first track.
- If no CD is inserted, "NO DISC" appears on the display and the CD Player remains in Stop mode.

Setting a CD

1. Turn the CD cover knob counterclockwise to open the CD cover.
2. Place a CD, with its label side up as shown below.

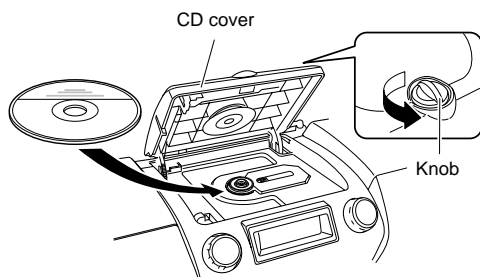

3. Close the CD cover until it clicks.
- To remove the CD, open the CD cover in Stop mode.
 - You can place an 8 cm (3") CD without an adaptor.
 - If the CD cannot be read correctly (because it is scratched, for example), "0 0:00" appears on the display.
 - You can place a CD while listening to the other source.

Basics of Using the CD Player-Normal Play

To Play a CD

1. Set a CD.
2. Press the CD▶/|| button.

The first track of the CD begins playing.

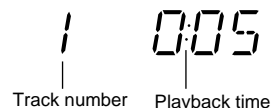

- The CD Player automatically stops when the last track of the CD has finished playing.

To stop playing the CD, press the ■ button. The following information for the CD is displayed.

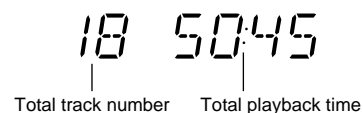

To pause, press the CD ▶/|| button. The playback time blinks on the display.

To cancel pause, press the same button again. Play continues from the point where it was paused.

Note: Do not open the CD cover during playback.

Locating a Track with Remote Control Directly

During playback or in Stop mode, press the number keys on the Remote Control to directly play a track.

To directly play the track 5, press 5.

To directly play the track 15, press +10 then 5.

To directly play the track 20, press +10 once then press 10.

To Select a Track

During playback, press the ◀◀ or ▶▶ button to select the track you want.

The selected track starts playing.

- Press the ▶▶ button once to skip to the beginning of the next track.
- Press the ◀◀ button to skip to the beginning of the track being played. Press the ◀◀ button twice quickly to skip to the beginning of the previous track.

You can also select a track in Stop mode with the same buttons. When the button is pressed, the selected track and its playback time appear on the display. To play the CD after selecting a track, just press the CD ▶/|| button.

Search Play

Holding down the ◀◀ or ▶▶ button, during playback, will fast forward/backwards the CD so you can quickly find a particular passage in the track you are listening to. During Search Play, you can hear the sound of approx. one forth level.

Programming the Playing Order of the Tracks

You can program the playing order of the tracks using the Remote Control.

- You can program up to 20 tracks in any desired order including the same tracks.
- You can only make a program when the CD Player is stopped.

1. Set a CD.

2. Press the CD▶/|| button.

3. Press the ■ button to stop the CD.

4. Press the PROGRAM button.

The System enters the programming mode and the "PROGRAM" indicator lights up.



5. Press the number keys to select the track to program.

To select the track 5, press 5.

To select the track 15, press +10 then 5.

To select the track 20, press +10 once then press 10.

Example: for track 2, press 2.

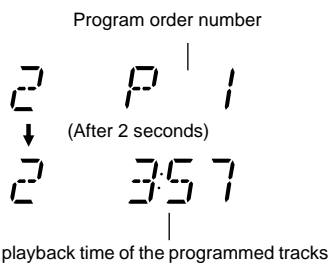

6. Repeat step 5 to select the other tracks for the program.

You can see the total playback time of the programmed tracks on the display.

- To cancel the last track programmed, press the ■ button once.

7. Press the CD ▶/|| button.

The System plays the tracks in the order you have programmed them.

- You can skip to a particular program track by pressing the ◀◀ or ▶▶ button during Program Play.

To confirm the programmed tracks while the CD player is stopped, press the ◀◀ or ▶▶ button; the tracks making up the program will successively be displayed in the programmed order.

To delete all the tracks in the program, press the ■ button repeatedly until all the tracks are cleared. Turning off the power will also clear the programmed tracks.

To exit Program mode, while the CD Player is stopped, press the PROGRAM button to turn off the "PROGRAM" indicator. To restore Program mode, in Stop mode, press the same button to light on the "PROGRAM" indicator.

Notes:

- If the total playback time of the programmed tracks exceeds 99 minutes 59 seconds, the total playback time will go out on the display.
- When the CD contains more than 21 tracks: When you try to program a track number exceeding 20 (for example the 25th track), the total playback time indication will go out, though programming is possible.

To Modify the Program

Modify the contents of the program while the CD Player is stopped. Each time you press the ■ button, the last track in the program is deleted. To add new tracks to the end of the program, repeat above steps 5 and 6.

Random Play

The tracks will play in no special order when you use this mode.

1. Press the RANDOM button on the Remote Control.

The "RANDOM" indicator lights up on the display.

2. Press the CD▶/|| button.

The tracks are played in random order once.

To skip a track during playback, press the ▶▶ button to jump to the next track in the random sequence. Press the ◀◀ button to jump back to the start of a track being played.

To exit Random Play mode, press the RANDOM button to turn off the "RANDOM" indicator after pressing the ■ button to stop the CD Player, or turn off the power.

Repeating Tracks

You can repeat the tracks or individual track as many times as you like.

Press the REPEAT button on the Remote Control.

The Repeat indicator changes with each press of the button, as shown below.

☞ → ☞ **ALL** → blank display → (back to the beginning)

☞ : Repeats one track.

☞ **ALL** : In Normal Play mode, repeats all the tracks.

In Program Play mode, repeats all the tracks in the program.

In Random Play mode, repeats all the tracks in random order.

To exit Repeat mode, press the REPEAT button until the Repeat indicator on the display goes out.

- In Random Play, ☞ cannot be selected.

- Repeat mode remains in effect even when you change the play mode.

Using the Cassette Deck (Listening to a Tape)

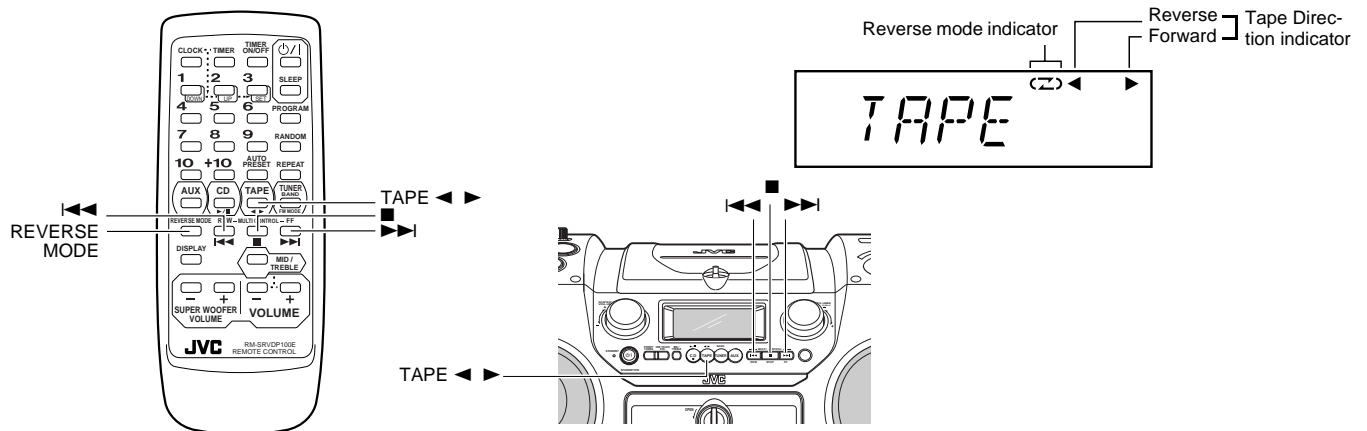

The Cassette Deck allows you to play and record audio tapes.

- With Automatic Tape Detection, you can listen to type I, II or IV tapes without having to change any settings.

The use of tapes longer than 120 minutes is not recommended, since characteristic deterioration may occur and these tapes easily jam in the pinch-rollers and the capstans.

One Touch Play

This operation is effective only when the System is operated on AC power.

By pressing the TAPE ◀ ▶ button on the Unit or the Remote Control, the System will come on, "TAPE" appears on the display, and if a tape is in the deck, it will start to play. If no tape is loaded, insert a tape, or select other function.

Regular Play

When the power is already on, you can use this basic procedure:

1. Turn the cassette holder knob counterclockwise to open the cassette holder.
2. Put the cassette in, with the side you want to listen facing toward you.

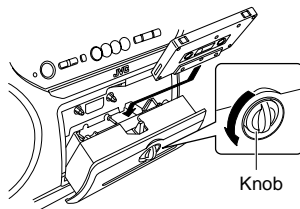

3. Close the holder gently until it clicks.

4. Press the TAPE ◀ ▶ button.

The tape is played in the direction shown by the Tape Direction indicator. The Tape Direction indicator ▶ (Forward) or ◀ (Reverse) blinks slowly.

▶ (Forward playback):

The side of the tape facing you is played back.

◀ (Reverse playback):

The opposite side of the tape is played back.

5. If you need to change the playback direction, press the TAPE ◀ ▶ button.

The opposite side Tape Direction indicator lights up and the tape playback direction changes.

To stop playing, press the ■ button.

To remove the tape, stop the tape, and open the cassette holder by turning the cassette holder knob counterclockwise.

To Fast-Wind A Tape

Press the ▶▶ or ◀◀ button to fast-wind the tape. The Tape Direction indicator ▶ or ◀ will rapidly blink on the display.

- The Cassette Deck automatically stops when the tape reaches its end.

The following table shows the relationship between the Tape Direction indicator and the actual tape travelling direction in each mode. The tape travelling direction is indicated by the blinking indicator.

[Tape Direction indicator and tape travelling direction in each mode]

	Stop	Playback	▶▶ FF	◀◀ REW
Forward	▶	▶ (Slow)	▶▶ (Rapid)	▶ (Rapid)
Reverse	◀	◀ (Slow)	◀ (Rapid)	◀▶ (Rapid)

*Blinking indicator shows the tape travelling direction.

Reverse Mode

You can set a tape to play just one side, both sides in succession, or both sides continuously.

Press the REVERSE MODE button on the Remote Control.

The Reverse mode indicator changes with each press of the button as shown.

◀→▶ → ▶→▶ → (back to the beginning)

- ◀→▶ : The Cassette Deck automatically stops after playing one side of the tape.
- ▶→▶ : The Cassette Deck automatically stops after playing both sides of the tape. (Stops when playback in the reverse (◀) direction is finished.)
- ▶→▶ : The Cassette Deck continues to play both sides of the tape until the ■ button is pressed.

Using the Cassette Deck (Recording)

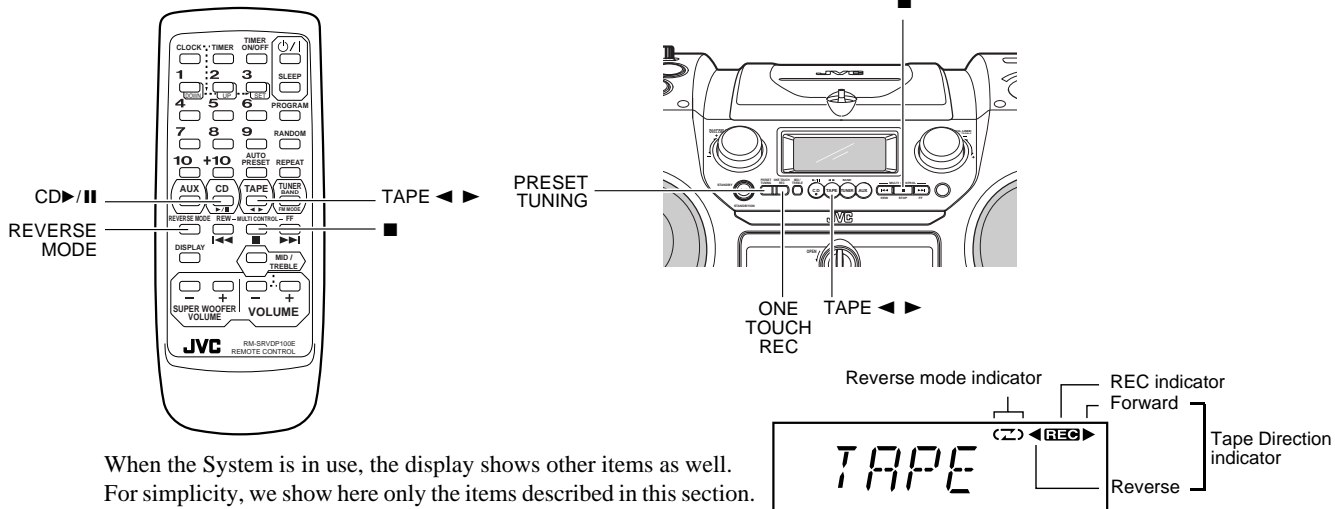

Recording onto a tape from any of the sound sources is simple. Just place a tape in the Cassette Deck, have the source ready, make one or two settings, and you're ready to record. For each source the procedure is a little bit different so we explain each separately. But first, here are a few things to make your recordings better.

Things To Know Before You Start Recording

- It should be noted that it may be unlawful to re-record per-recorded tapes, records, or discs without the consent of the owner of copyright in the sound or video recording, broadcast or cable programme and in any literary, dramatic, musical, or artistic work embodied therein.
- When you want to record onto both sides of a tape, you can set Reverse mode to do so. Recording automatically stops after recording in the reverse (◀) direction. Therefore, make sure that the tape direction is forward (▶) when recording with Reverse mode on.
- The recording level, which is the volume at which the new tape is being made, is automatically set correctly, so it is not affected by the VOLUME control on the System. Nor is it affected by adjusting the sound effects. Thus, during recording you can adjust the sound you are actually listening to without affecting the recording level.
- Two small tabs on the back of the cassette tape, one for side A and one for side B, can be removed to prevent accidental erasure or recording.
- To record on a cassette with the tabs removed, you must cover the holes with adhesive tape first. However, when a type II tape is used, only cover part of the hole as shown, since the other part of the hole (Type II detection slot) is used to detect the tape type.

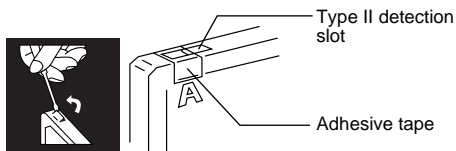

- Type I and Type II tapes can be used for recording.

Note: At the start and end of cassette tapes, there is leader tape which cannot be recorded onto. Thus, before recording, wind on the leader tape first to ensure getting the beginning of the recording.

CAUTION: If a recording you make has excessive noise or static, the System may have been too close to a TV which was on during the recording. Either turn off the TV or increase the distance between the TV and the System.

Standard Recording

You can record any sound source to tape. The sources are CD, Tuner, auxiliary equipment, Rhythm Machine, microphone and guitar. The microphone sound and guitar sound can be mixed with any source. Also, you can mix the sound from the Rhythm Machine with the CD or auxiliary equipment.

1. Insert a blank or erasable cassette tape into the Cassette Deck.

Be sure that the Tape Direction indicator and the tape insertion direction are as follows:

[Forward recording]

Tape Direction indicator	Tape insertion direction
▶ (Forward)	 (Front view)

*Recording will be made on the tape side facing you.

- If the Tape Direction indicator ◀ (Reverse) is lit, press the TAPE ◀ ▶ button to change the direction. (In this case, since the tape is played, you need to press the ■ button. Then, press the ◀◀ button to rewind the tape. You may need to wind past the leader tape which cannot be recorded onto.)
- If the inserted tape is not fully rewound, press the ◀◀ button to rewind it. You may need to wind past the leader tape which cannot be recorded onto.

- If you want to record on both sides of the tape, press the REVERSE MODE button on the Remote Control to set the System in Reverse mode.**

Press the button until \curvearrowright indicator is lit.

- Prepare the source, by, for example, tuning in a radio station, playing the Rhythm Machine, or turning on the connected auxiliary equipment.**

Note: For CD recording, refer to "CD Direct Recording" described below.

- Press the ONE TOUCH REC button on the Unit.**

The "REC" indicator lights up and the System starts recording.

- If the tab of the cassette tape is removed to protect erasure or recording, recording does not start.

TIP: When you want to record in the reverse direction, you should set the Tape Direction indicator and the cassette tape as follows in step 1. Next, start from step 3.

[Reverse recording]

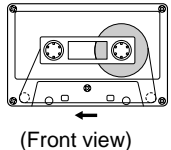
Tape Direction indicator	Tape insertion direction
 (Reverse)	 (Front view)

*Recording will be made on the opposite side tape.

To stop at any time during the recording process, press the ■ button.

Recording an AM station to tape

When recording an AM broadcast, beats may be produced which are not heard when listening to the broadcast. If this happens, press the PRESET TUNING button on the Unit to eliminate the beats.

- Set to AM station and start recording.
- Press the PRESET TUNING button to eliminate the beats. Each time you press the button, the display changes as shown below:
CUT-1 → CUT-2 → CUT-3 → CUT-4 → (back to the beginning)

CD Direct Recording

Everything on the CD goes onto the tape in the order it is on the CD, or according to the order you have set in a program.

- Insert a blank or erasable cassette tape into the Cassette Deck.**

Be sure that the Tape Direction indicator and the tape insertion direction are as follows:

(For details, refer to step 1 in "Standard Recording" on page 13.)

[Forward recording]

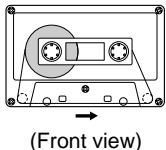
Tape Direction indicator	Tape insertion direction
 (Forward)	 (Front view)

*Recording will be made on the tape side facing you.

- If you want to record on both sides of the tape, press the REVERSE MODE button on the Remote Control to set the System in Reverse mode.**

Press the button until \curvearrowright indicator is lit.

- Set a CD.**

- Press the CD ►/II button.**

- Press the ■ button.**

- If you want to record specific tracks only, program the tracks first. You can check their total playback time on the display during programming. (See page 11.)

- Choose whether to have pauses between recorded selections.**

- If nothing is done, a non-recorded pause of about four seconds will be automatically left between selections.
- If you do not want pauses between selections, do the following before proceeding to the next step.
 Press the CD ►/II button twice to enter Pause mode.

- Press the ONE TOUCH REC button on the Unit.**

The "REC" indicator lights up and the System starts recording.

- If you make a recording with Reverse mode on, the System will record the last song at the end of the first side onto the next side from its beginning when the song has been recorded more than 10 seconds on the first side.
 If the last song has been recorded less than 10 seconds, then the previous song will again be recorded on the next side as it will not be completely recorded on the first side because of leader tape.
- After the CD Player has played the entire CD, or all the programmed tracks, the tape automatically stops.

To stop at any time during the recording process, press the ■ button. The tape stops after four seconds.

Note: When making SLEEP timer settings while doing CD Direct recording, set enough time to allow for the CD to finish playing, otherwise the power will go off before recording is completed.

One Track Recording

You can record the one CD track being played.

- Insert a blank or erasable cassette tape into the Cassette Deck.**

- Play the track on the CD you wish to record.**

- Press the ONE TOUCH REC button on the Unit.**

The CD Player returns to the beginning of that track and the track is recorded on the tape. After recording, the CD Player and the Cassette Deck automatically stop.

Using the Rhythm Machine

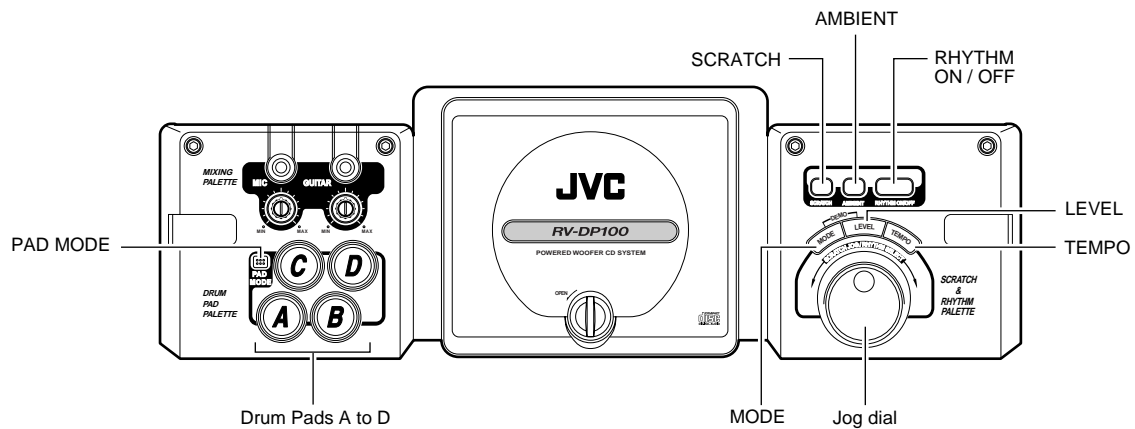

You can enjoy to play the Rhythm Machine that can generates many sound patterns shown below.

- **Ambient pattern** : WAVES and BIRDS
- **Rhythm pattern** : 36 rhythm patterns
- **Scratch sound** : 2 scratch sounds using the Jog dial on the Unit
- **Drum pad pattern** : 20 pad patterns using the Drum Pads A to D on the Unit

You can play the Rhythm Machine alone or you can play it while the other music source except Tuner is played.

The following shows the functional block diagram of the Rhythm Machine. As an example, signal flows that may be used are shown with the thick gray lines. From this example, you can see that the scratch sound and the drum pad pattern can be mixed with the Rhythm pattern. Also, you can see that the music source (MIC and guitar in this example) can be mixed with the output of the Rhythm Machine.

Note: The Rhythm Machine does not work if Tuner is selected.

[RHYTHM MACHINE]

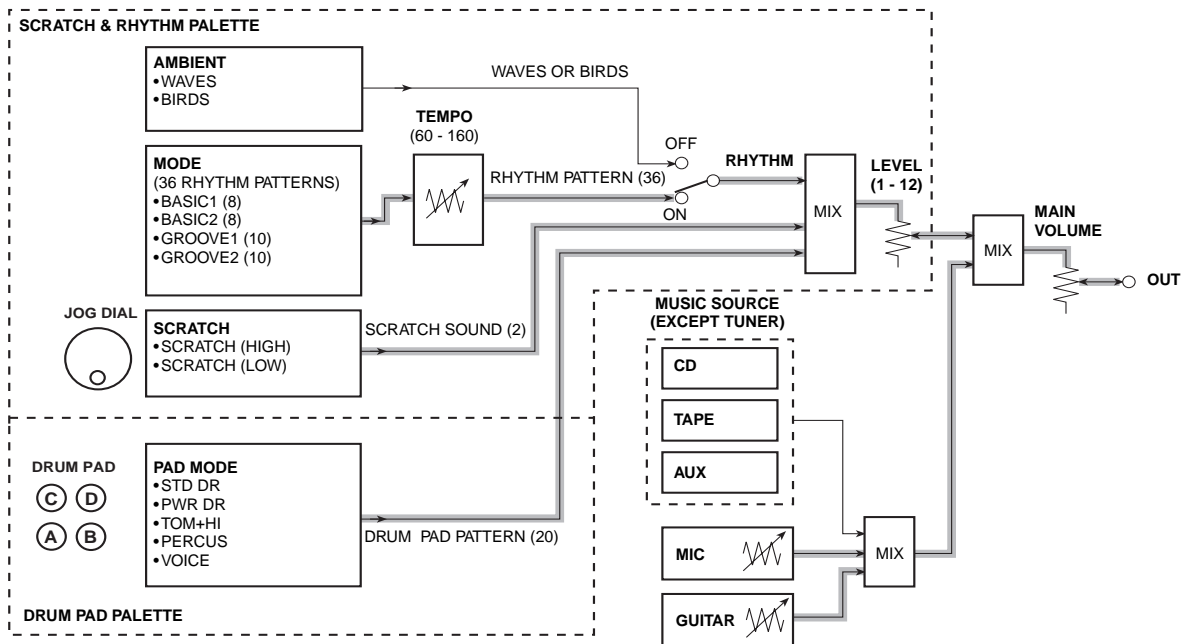

Limitation on Rhythm Pattern's Sound:

The Rhythm Machine has three sound sources and the maximum number of sounds that can be generated from the Rhythm Machine at a time is three.

Since two or three sounds are used for playing the rhythm pattern, the available sounds for playing the rhythm pattern will be reduced when you generate the pad pattern and/or scratch sound. In this case, the rhythm pattern's sound will be changed.

Example:

The 8 BEAT-1 rhythm pattern you are playing uses three sounds.

- When you generate the pad pattern by pressing the Drum Pad A or when you generate the scratch sound by turning the Jog dial, the number of sounds that will be assigned to the 8 BEAT-1 rhythm pattern will be reduced to two.
- When you generate the pad pattern and scratch sound at the same time, the number of sounds that will be assigned to the 8 BEAT-1 rhythm pattern will be reduced to one

Basic Operation-Adjusting the Rhythm Machine Volume

You can adjust the volume for the Rhythm Machine at any time except when Tuner is selected.

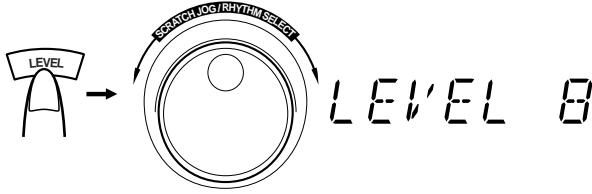

1. Press the LEVEL button on the Unit.

The current level will appear on the display for five seconds.

2. Within five seconds, turn the Jog dial to increase or decrease the volume level.

You can adjust the volume level for the Rhythm Machine between 1 and 12.

Playing the Ambient Pattern

You can generate WAVES and BIRDS.

Press the AMBIENT button on the Unit.

Each time you press the button, the display changes as follows:

WAVES → **BIRDS** → **cancelled (Original display)** →

(back to the beginning)

WAVES : Waves beat upon the seashore.

BIRDS : Birds sing.

To stop playing the ambient pattern, press the AMBIENT button until the display returns to the original one. Also, pressing the RHYTHM ON/OFF button once or switching the music source (e.g. from AUX to CD) will stop playing the ambient pattern.

Note: You cannot play the ambient pattern if Tuner is selected.

TIP: It may be a good idea that you use BIRDS and WAVES to fall asleep. For this setting, see "Setting the Sleep Timer" on page 23.

Playing the Rhythm Pattern

You can play one of 36 rhythm patterns shown in the "36-Rhythm Pattern Table":

[36-Rhythm Pattern Table 1/2]

TEMPO: Initial Setting

■ BASIC1 (8 patterns)

2/4/8 BEAT Basic Rhythm Group:

Can be used for rock, pop, jazz and other music genres.

Can also be used for instrument practice or dance instruction.

No.	Pattern Name	Tempo	Contents/Character
1	8BEAT-1	120	8BEAT pattern No. 1. 8 Beat Basic Pattern, Ideal for rock and pop.
2	8BEAT-2	132	8BEAT pattern No. 2. 8 Beat With Fill-In. Ideal for Rock Type Interval Sections, etc.
3	8BEAT-3	120	8BEAT pattern No. 3. Medium Tempo 8 Beat. Ideal for Slow Rock.
4	8BEAT-4	120	8BEAT pattern No. 4. Medium Tempo 8 Beat. Ideal for After-Beat type.
5	2BEAT-1	120	2BEAT pattern No. 1. Power Type 2 Beat. Suited to Punk Rock.
6	2BEAT-2	120	2BEAT pattern No. 2. Suited to Hard Rock and Heavy Metal.
7	4BEAT-1	112	4BEAT pattern No. 1. Ideal for Modern Jazz and Bebop.
8	4BEAT-2	90	4BEAT pattern No. 2. Ideal for Modern Jazz. Accents with high hat.

■ BASIC2 (8 patterns)

Ideal for playing at parties or for background music for latin or ethnic music from Latin America.

No.	Pattern Name	Tempo	Contents/Character
1	SAMBA	120	Suited to samba-like sound.
2	SALSA	120	Suited to salsa-like sound.
3	REGGAE	80	Suited to reggae-like sound.
4	JUNGLE1	140	Suited to ethnic music.
5	JUNGLE2	140	Suited to ethnic music.
6	16BEAT1	120	16 Beat Pattern No. 1 16 Beat Basic Pattern
7	16BEAT2	120	16 Beat Pattern No. 2 Ideal for techno-type 16 beat/pops.
8	16BEAT3	120	16 Beat Pattern No.3 Ideal for power type 16 beat.

[36-Rhythm Pattern Table 2/2]

■ GROOVE1 (10 patterns)

Ideal for street performances with group music concentrating on "rap" or "house."

No.	Pattern Name	Tempo	Contents/Character
1	DR'B-1	160	Drum & Bass Pattern No. 1 Abbreviation for Drum & Bass
2	DR'B-2	160	Drum & Bass Pattern No. 2
3	DR'B-3	160	Drum & Bass Pattern No. 3
4	RAP-1	120	Rap Pattern No. 1 Rap Music: Simple rhythms plus talking voice
5	RAP-2	120	Rap Pattern No. 2
6	RAP-3	120	Rap Pattern No. 3
7	HOUSE-1	94	House Pattern No. 1 Common name for House Made Music
8	HOUSE-2	120	House Pattern No. 2
9	HOUSE-3	120	House Pattern No. 3
10	G-BEAT	94	Ground Beat Pattern Low tone + slow tempo and high hat for a laid-back sound.

■ GROOVE2 (10 patterns)

Ideal for creating and practicing the club sound which is popular now for group music concentrating on techno, funk and hip-hop.

No.	Pattern Name	Tempo	Contents/Character
1	HIPHOP1	120	Hip-Hop Pattern No. 1 Hip-Hop Music
2	HIPHOP2	120	Hip-Hop Pattern No. 2
3	FUNK-1	120	Funk Pattern No. 1 Funk Music
4	FUNK-2	120	Funk Pattern No. 2
5	TECHNO1	120	Techno Pattern No. 1 Common name of Technology Music
6	TECHNO2	120	Techno Pattern No. 2 Common name of Technology Music
7	DANCE-1	120	Dance Pattern No. 1 Present dance scene. Image of Euro Disco type music.
8	DANCE-2	120	Dance Pattern No. 2 Power Disco image
9	DANCE-3	120	Dance Pattern No. 3 Street Dance image
10	MARIAN	120	Amusement Pattern with woman's voice (Marian).

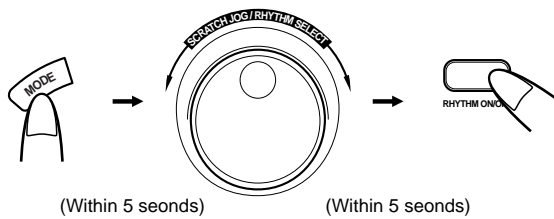

1. Press the MODE button on the Unit to select your favorite Rhythm mode.

Each time you press the button, mode changes as follows.

BASIC1→BASIC2→GROOVE1→GROOVE2→
(back to the beginning)

- The display will return to the original one after five seconds.

2. Within five seconds, turn the Jog dial to select your favorite rhythm pattern.

For example, if you select "BASIC1" in step 1, the pattern will change as follows as you turn the Jog dial clockwise.

8BEAT-1→8BEAT-2→... →4BEAT-2→
(back to the beginning)

3. Press the RHYTHM ON/OFF button on the Unit.

The selected pattern will be repeatedly played.

To stop playing, press the RHYTHM ON/OFF button once again. Switching the music source (e.g. from AUX to CD) will also stop playing.

To restart playing, press the RHYTHM ON/OFF button again, the current pattern appears on the display and playback starts.

Note: You cannot play the rhythm pattern if Tuner is selected.

Changing the Playing Rhythm Pattern

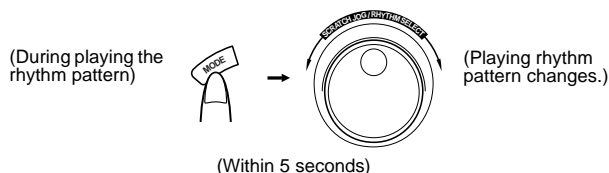

1. During playing the rhythm pattern, press MODE button on the Unit to select your favorite Rhythm mode.

2. Within five seconds, turn the Jog dial to select your favorite rhythm pattern.

The selected rhythm pattern will be played.

Adjusting the Tempo During Playback

1. During playing the rhythm pattern, press the TEMPO button on the Unit.

The current tempo appears on the display for five seconds.

TMP 120

2. Within five seconds, turn the Jog dial to increase or decrease the tempo.

You can adjust the tempo between 60 and 160.

- The tempo you have changed will be maintained even when the System is turned off. However, it will be reset to the initial value when you select other rhythm pattern.

Generating Scratch Sound

You can generate two kinds of scratch sound (scratch-high and scratch-low) by turning the Jog dial.

The scratch sound can be mixed with the following all sources together.

- BIRDS, WAVES, or rhythm pattern generated from the Rhythm Machine
- Dram pad pattern generated from the Rhythm Machine
- Music source except Tuner
- MIC and Guitar inputs



1. Press the SCRATCH button on the Unit.

"SCRATCH" will appear on the display.

2. Turn the Jog dial to generate the scratch sound.

When you turn the Jog dial clockwise or counterclockwise, the scratch-high sound or scratch-low sound will be generated, respectively. When you turn the Jog dial rapidly, the scratch sound will be generated continuously.

To stop the scratch sound generation, press the SCRATCH button once again to display "OFF".

Note: You cannot generate the scratch sound if Tuner is selected.

Generating the Pad Pattern

You can generate 20 pad patterns by pressing the Drum Pads A to D on the Unit. Pad patterns are assigned to the Drum Pads A to D in each Pad mode as shown in the "Pad Pattern Table".

The pad pattern can be mixed with the following all sources together.

- BIRDS, WAVES, or rhythm pattern generated from the Rhythm Machine
- Scratch sound generated from the Rhythm Machine
- Music source except Tuner
- MIC and Guitar inputs

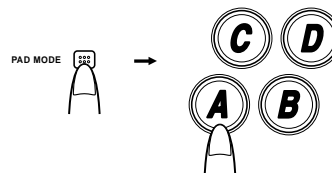

1. Press the PAD MODE button on the Unit to select Pad mode.

Each time you press the button, mode changes as follows.
STD DR→**PWR DR**→**TOM+HI**→**PERCUS**→**VOICE**→**OFF**→(back to the beginning)

2. Press the Drum Pads A to D on the Unit.

Each time you press the Pad, corresponding pad pattern which is shown in the "Pad Pattern Table" will be generated.

Note: You cannot play the Pad pattern if Tuner is selected.

[Pad Pattern Table]

PAD MODE Pad	STD DR (Standard Drum)	PWR DR (Tom + Hihat)	TOM+HI (Tom & Hihat)	PERCUS (Percussion)	VOICE (Voice, etc.)	OFF
A	Standard-Bass Drum	Power-Bass Drum	High Floor Tom	High Agogo	Marian	—
B	Standard Snare	Power Snare	Low Floor Tom	Low Agogo	Yeh!	—
C	Standard-Closed Hihat	Power-Closed Hihat	Open Hihat	Open Hi Conga	Gun	—
D	Power-Crash Cymbal	Power-Crash Cym- bal	Pedal Hihat	Hand Clap	Engine	—

Abbreviations:

STD DR: Standard drum kit (bass, snare, high-hat, cymbal) **PWR DR:**Power drum kit **TOM+HI:**Tomtom and high-hat group **PERCUS:**Percussion, ethnic percussion **VOICE:**Voice and onomatopoeic sounds

Rhythm Machine Demo Mode

You can play the demo pattern repeatedly.

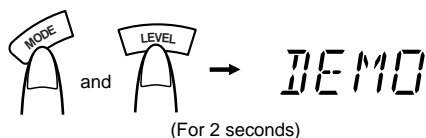

1. When the Rhythm Machine is stopped, press and hold the MODE and LEVEL buttons on the Unit for more than two seconds.

Demonstration starts and a series of demo pattern is played.

ENGINE→DR'B-1→DR'B-3→RAP-3→HIPHOP2→

FUNK-1→TECHNO1→HIPHOP1→DANCE2→

DANCE3→MARIAN→ (back to the beginning)

2. Press the RHYTHM ON/OFF button on the Unit to stop playing the demo pattern.

- Changing the music source (e.g. form AUX to CD) will also stop playing.

Notes:

- You cannot change the level and tempo of the demo pattern.
- You cannot play the demo pattern if Tuner is selected.

Listening to an Auxiliary Equipment

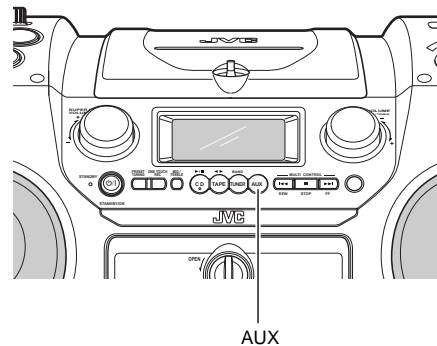
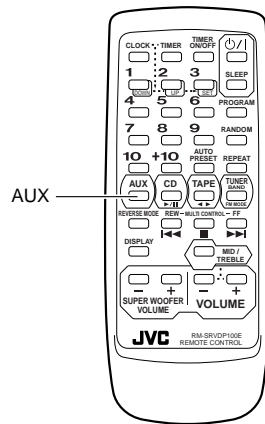

Listening to External Equipment

You can listen to an auxiliary equipment.

- First make sure that the auxiliary equipment is properly connected to the System.(See page 3).

1. Set the volume level to minimum.

2. Press the **AUX** button.

"AUX" appears on the display.

AUX

- To listen to the auxiliary equipment, start playing the auxiliary equipment.

3. Adjust the volume to the desired listening level.

4. Apply sound effects, if you wish.

- Adjust the super woofer volume to reinforce the bass sound.
- Adjust the MID/TREBLE to control the tone. (See "Tone Control (MID/TREBLE)" on page 7.)

Note: For operation of the auxiliary equipment, refer to its Instructions.

Using the Microphone/Guitar

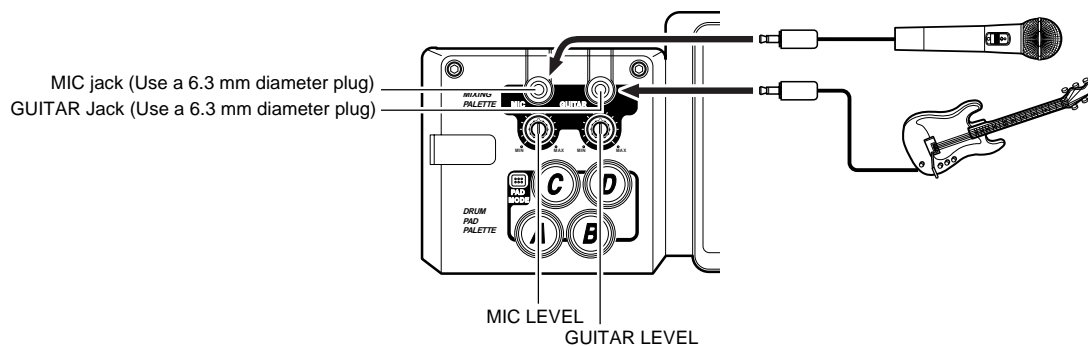

Microphone Mixing

Using a microphone (not supplied), you can mix the microphone sound with a source sound.

- 1. Set the MIC LEVEL control to MIN by turning it fully counterclockwise.**
- 2. Open the rubber cap and plug a microphone into the MIC jack on the Unit.**
- 3. Start a source: CD, tape, tuner, Rhythm Machine, or other equipment.**
- 4. Adjust the main volume and the MIC LEVEL control, as you sing into the microphone.**

To Record Microphone Mixing on a Tape

- 1. Follow the above steps 1-4.**
- 2. To record, follow the steps in "Standard Recording". (See page 13.)**

Note: If "howling" occurs, keep the microphone away from the Unit.

Guitar Mixing

Using a guitar, you can mix the guitar sound with a source sound.

CAUTION: DO NOT connect a bass guitar to the GUITAR jack, as it may damage the System.

- 1. Set the GUITAR LEVEL control to MIN by turning it fully counterclockwise.**
- 2. Open the rubber cap and plug a guitar into the GUITAR jack on the Unit.**
- 3. Start a source: CD, tape, tuner, Rhythm Machine, or other equipment.**
- 4. Adjust the main volume and the GUITAR LEVEL control, as you play the guitar.**

To Record Guitar Mixing on a Tape

- 1. Follow the above steps 1-4.**
- 2. To record, follow the steps in "Standard Recording". (See page 13.)**

Using the Timers

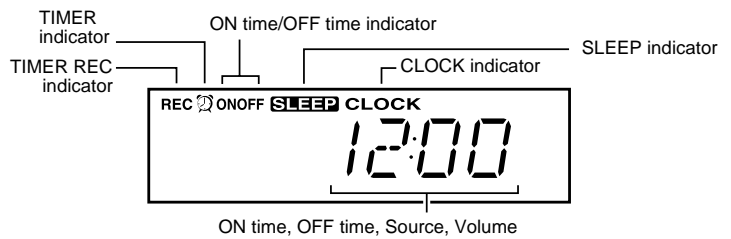
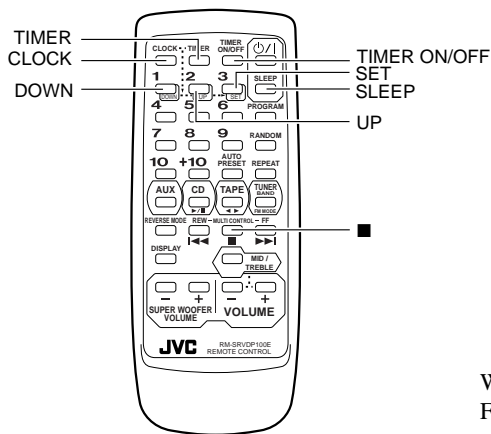

When the System is in use, the display shows other items as well. For simplicity, we show here only the items described in this section.

The timers let you control listening and recording functions automatically.

Setting the Clock

When you supply the power using one of the following ways, the "CLOCK" indicator blinks and "0:00" appears on the display. You need to set the clock.

- Plugging the AC power cord into the wall outlet
- Loading 10 batteries into the Unit
- Connecting car battery (DC12V)

Use the Remote Control to set the clock.

Notes:

- The clock must be correctly set for the timers to work.
- The procedure must be completed within **two minutes**. Otherwise, the setting is cleared and must be repeated from the beginning.

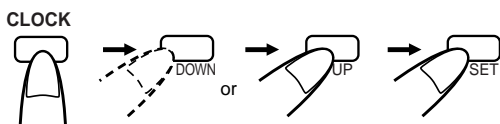

1. Turn on the System.

2. Press the CLOCK button on the Remote Control.

The time indication blinks on the display.

3. Press the UP or DOWN button to set the time.

Press the UP or DOWN button to increase or decrease the time. Pressing and holding the button will change the time rapidly.

4. Press the SET button.

The selected time is set and the seconds start counting from 0. Then, the display returns to the original one.

CAUTION: If memory backup batteries are exhausted or not installed, and the AC power cord is plugged in again after being disconnected, or power is restored after a power failure, "CLOCK" indicator will blink on the display. Set the current time (clock) again.

Setting the Daily Timer

Once you have set the Daily Timer, the timer will be activated at the same time every day, except for the Tuner REC timer which is used to record a broadcast on the tape. It can be cancelled and reactivated whenever you wish.

The Timer indicator () on the display shows when the Daily Timer you have set is in effect.

Use the Remote Control to set the Daily Timer.

Note: Perform each setting within **30 seconds**. Otherwise, setting is cleared and the procedure must be repeated from the beginning.

1. Turn on the System.

2. Setting the ON time (Example: 12:15).

1. Press the TIMER button on the Remote Control. The Timer indicator () and "ON" indicator light up and the current ON time blinks on the display.



2. Set the ON time by pressing the UP or DOWN button. Pressing and holding the button will change the time rapidly.



3. Press the SET button. The current OFF time blinks on the display.



3. Setting the OFF time (Example: 13:15).

1. Set the OFF time by pressing the UP or DOWN button.
Pressing and holding the button will change the time rapidly.



2. Press the SET button.
The music source "TUNER" blinks on the display.

4. Selecting the music source.

1. Press the UP or DOWN button to select the music source you want to listen to. The display changes as shown below:
TUNER→**TUNER REC**→**CD**→**TAPE**→**RHYTHM**→
(back to the beginning)
 - When you select the "TUNER REC", the "REC" indicator appears on the display.
 - When you select the "TUNER REC", the timer will be released after Tuner Recording has been finished.
2. Press the SET button.
The volume level set by the previous time setting blinks on the display.

5. Setting the volume level.

1. Press the UP or DOWN button to select the volume level.
— : The current volume level will be used.
0 to 50: When the timer is turned on, the Volume will be automatically set to the selected level.



2. Press the SET button.
The timer setting is completed and the display returns to the display before you set the timer. The Timer indicator () remains lit.

6. Before turning off the System, prepare the music source selected in step 4.

- TUNER** : Tune in to the desired station.
- TUNER REC**: Tune in to the desired station and insert a cassette tape for recording the station.
- CD** : Set a CD.
- TAPE** : Insert a tape.
- RHYTHM** : Select your favorite pattern from the 36 rhythm patterns.

7. Turn off the System.

- When the timer turns on, the volume level gradually increases from 0 (zero) to the preset level in step 5.
- To cancel the operation**, press the TIMER button until the display returns to the original one.
- To cancel the timer**, press the TIMER ON/OFF button. The Timer indicator () goes out on the display.
- To reactivate the cancelled timer**, press the TIMER ON/OFF button to light the Timer indicator ().
- To confirm the timer settings**, press the TIMER button. Then, press the SET button repeatedly to see the current timer settings (ON time, OFF time, source, and volume).
- To change the timer setting**, repeat the setting procedure from the beginning.

CAUTION: If memory backup batteries are exhausted or not installed, and the AC power cord is disconnected or there is a power failure, time settings will be erased from memory. If this happens, set the current time (clock) and perform the timer setting again.

Setting the Sleep Timer

Use the Sleep Timer to turn the System off after a certain number of minutes when it is playing. By setting the Sleep Timer, you can fall asleep to music and know that your System will turn off by itself rather than play all night.

- You can only set the Sleep Timer when the System is on and a source is playing.

1. Play a CD, tape, tune in to the desired station, or play the Rhythm Machine.

If you play "WAVES" in the Rhythm Machine, you may fall asleep to the waves that beat upon the seashore.

2. Press the SLEEP button on the Remote Control.

The SLEEP indicator lights up on the display.



3. Set the length of time you want the source to play before shutting off.

- Each time you press the SLEEP button, it changes the number of minutes shown on the display in this sequence:
→ **30** → **60** → **90** → **120** → Cancelled (Original display)→
(back to the beginning)

After setting the number of minutes for the Sleep Timer, the display will stop blinking and return to the display as before setting the Sleep Timer.

The System is now set to turn off after the number of minutes you set.

To Confirm the Sleep Time:

When the SLEEP button is pressed, the remaining sleep time is displayed. Wait until the display returns to the original display.

To Cancel the SLEEP Timer Setting:

Press the SLEEP button until the original display appears on the display. Turning off the System also cancels the SLEEP Timer.

- If you are setting the Daily Timer, the System will be turned on at the set time to wake you up.

Care And Maintenance

Handle your CDs carefully, and they will last a long time.

Compact Discs



- Only CDs bearing this mark can be used with this System. However, continued use of irregular shape CDs (heart-shape, octagonal, etc.) can damage the System.



- Remove the CD from its case by holding it at the edges while pressing the case's center hole lightly.
- Do not touch the shiny surface of the CD, or bend the CD.

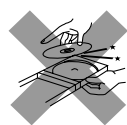

- Put the CD back in its case after use to prevent warping.
- Be careful not to scratch the surface of the CD when placing it back in the case.
- Avoid exposure to direct sunlight, temperature extremes, and moisture.



- A dirty CD may not play correctly. If a CD does become dirty, wipe it with a soft cloth in a straight line from center to edge.

CAUTION: Do not use any solvent (for example, conventional record cleaner, spray thinner, benzine, etc.) to clean a CD.

General Notes

In general, you will have the best performance by keeping your CDs and the mechanism clean.

- Store CDs in their cases, and keep them in cabinets or on shelves.
- Keep the system's CD cover closed when not in use.

Cleaning the lens

If the lens in the CD pickup is dirty, dropout, etc., could degrade sound. Open the CD cover and clean the lens as shown.

- Use a blower (available from a camera store) to blow dust off the lens.

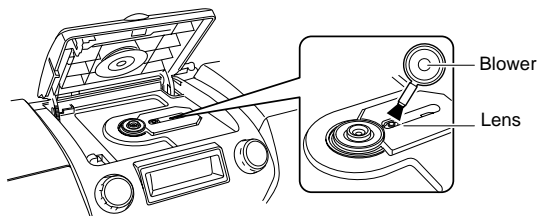

- If there are fingerprints, etc. on the lens, gently wipe clean with a cotton swab.

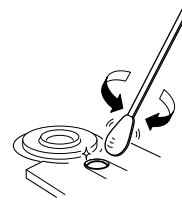

Moisture Condensation

Moisture may condense on the lens inside the System in the following cases:

- After turning on heating in the room.
- In a damp room.
- If the System is brought directly from a cold to a warm place.

Should this occur, the System may malfunction. In this case, leave the System turned on for a few hours until the moisture evaporates, unplug the AC power cord, and then plug it in again.



Cassette Tapes

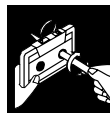

- If the tape is loose, it may get stretched, cut, or caught in the cassette. Take up the slack by inserting a pencil in one of the reels and rotating.



- Do not touch the tape surface.



- Do not store the tape:
 - In dusty places
 - In direct sunlight or heat
 - In moist areas
 - On a TV or speaker
 - Near a magnet

Cassette Deck

- If the heads, capstans, or pinch-rollers of the Cassette Deck become dirty, the following may occur:
 - Loss of sound quality
 - Discontinuous sound
 - Fading
 - Incomplete erasure
 - Difficulty recording
- Clean the heads, capstans, and pinch-rollers using a cotton swab moistened with alcohol.

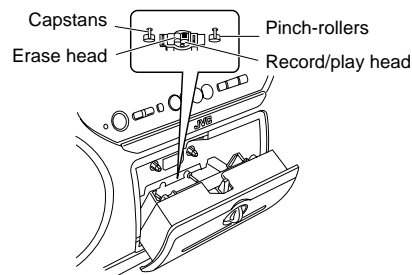

- If the heads become magnetized, the System will produce noise or lose high frequency notes.
- To demagnetize the heads, turn off the System, and use a head demagnetizer (available at electronics and record shops).

Troubleshooting

- If you are having a problem with your System, check this list for a possible solution before calling for service.
- If you cannot solve the problem from the hints given here, or

the System has been physically damaged, call a qualified person, such as your dealer, for service.

Symptom	Possible Cause	Action
No sound is heard.	<ul style="list-style-type: none"> • Connections are incorrect, or loose. • Headphones are connected. 	<ul style="list-style-type: none"> • Check all connections and make corrections. (See page 3.) • Disconnect the headphones.
Unable to record.	Cassette record protect tabs are removed.	Cover the holes on the back edge of the cassette with tape.
Poor FM reception	The FM telescopic antenna is not properly extended and positioned.	Fully extend the FM telescopic antenna and turn it for the best reception.
The CD skips.	The CD is dirty or scratched.	Clean or replace the CD.
The CD does not play.	The CD is upside down.	Put the CD in with the label side up.
Unable to operate the Remote Control.	<ul style="list-style-type: none"> • The path between the Remote Control and the sensor on the Unit is blocked. • The batteries have lost their charge. 	<ul style="list-style-type: none"> • Remove the obstruction. • Replace the batteries.
Operations are disabled.	The built-in microprocessor has malfunctioned due to external electrical interference.	Unplug the System then plug it back in after a few minutes.
The cassette holder cannot be opened.	During tape playing, the power cord was unplugged.	Plug in the power cord and press the $\odot/1$ button.

Specifications

Amplifier

Output Power	
(Max.)	20 W (10 W + 10 W) at 4 ohms (full range)
	40 W (20 W + 20 W) at 4 ohms, 60Hz (woofer)
(10% THD)	10 W (5 W + 5 W) at 4 ohms (full range)
	32 W (16 W + 16 W) at 4 ohms, 60Hz (woofer)
Input Sensitivity/Impedance (1 kHz)	
AUX IN	300 mV/47 kohms
MIC	200 ohms - 2 kohms (6.3mm dia. plug)
GUITAR	100 kohms - 1 Mohm (6.3mm dia. plug)
Output Sensitivity/Impedance (1 kHz)	
Phones	16 ohms - 1 kohms
	0 - 12 mW/ch output into 32 ohms

Cassette Deck

Frequency Response	
TypeII (CrO ₂)	60 Hz - 14 kHz
Wow and Flutter	0.15% (WRMS)

CD Player

Wow And Flutter	Unmeasurable
-----------------	--------------

Tuner

FM Tuner	
Tuning Range	87.5 MHz - 108.0 MHz
AM Tuner	
Tuning Range	(MW) 522 kHz - 1,629 kHz
	(LW) 144 kHz - 288 kHz
Antenna	FM telescopic antenna
	Ferrite core antenna for AM (MW/LW)

Speakers

Full range	8 cm × 2,	4 ohms
Super woofer	16 cm × 2,	4 ohms

General

Dimensions	634 mm × 256.5 mm × 311 mm (W/H/D)
Mass	10.2 kg (without batteries)
	11.3 kg (with batteries)

Accessories

Power Cord (1)
Remote Control (1)
Batteries R6P (SUM-3) / AA (15F) (2)
Shoulder Strap (1)

Power Specifications

Power Requirements	AC 230 V ~ , 50 Hz
	DC15V ("R20/D (13F)" batteries (10))
	External DC12V (car battery via optional CA-120E car adaptor)
Power Consumption	44 watts (power on mode)
	2 watts (in Standby mode)

Design and specifications are subject to change without notice.

JVC
VICTOR COMPANY OF JAPAN, LIMITED